



PlaySTEM USA
3002 Apollo Drive, Suite 10, Champaign, Illinois 61822
(1) 217-402-2040

PLAYSTEM EDUCATION
Suite 35-36 The Designworks, Park Parade, London, NW10 4HT

**PLAYSTEM CHINA
(ZT MODEL)**
No. 6 Mingde Rd., Puyan, Binjiang, Hangzhou, China



NEW
**PLAYSTEM
CATALOG**

WWW.PLAYSTEM.COM
SALES@PLAYSTEM.COM



INDEX

New Products	03
Home Series	11
Aeroplane Science	22
Love The Ocean	26
ToGo Science	31
Active Series	36
ZTF Car Series	42

*The product information is subject to change.





Read to be inspired!

Established in the UK in 2017, PlaySTEM provides outstanding-design and high-quality educational products with the purpose of helping children Play in a scientific way, Read the learning booklet and get Inspired.

In order to design products that bring children fun and arouse their curiosity, our designers from the UK, Hong Kong, France, come up with a variety of products concepts involving science, technology, engineering, mathematics and art.



NEW ADVENTURE WITH PLAYSTEM



ages
8+

Item number
XP03701

Packing size
340x225x75mm



WIND TURBINE SCIENCE PROJECTS SET

Learn about green energy! Assemble your own wind turbine and generate electricity from the wind to power your own electric motor glider and electric car. A hand crank is included for indoor use or when recharging the glider or car during calm days. Included Learning Booklet provides fun learning activities as well as instructions.

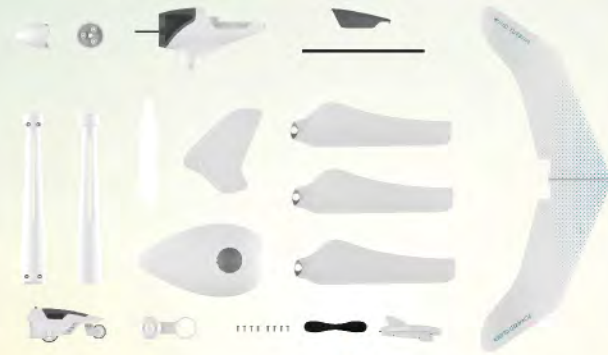

- 25 pieces
- 2 AA batteries required.



ages
6+

Item number
XP00901

Packing size
340x225x75mm



RC ROBOT SNAKE

Assemble a robotic snake to create a bio-inspired machine that emulates the unique snake-like locomotion found in nature. Use the wireless controller and take on the challenge of scoring a goal with the included mini soccer ball. Included Learning Booklet provides fun learning activities as well as instructions.

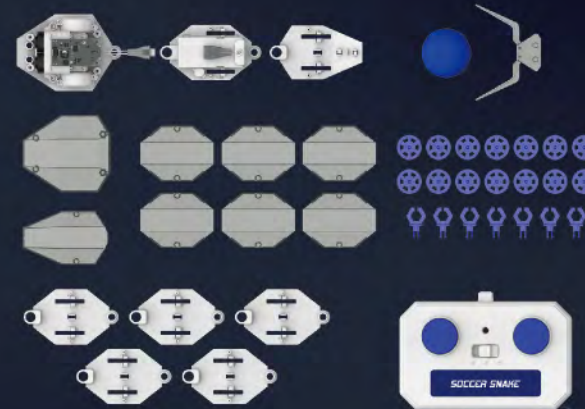

- 40 pieces
- 4 AAA batteries required.

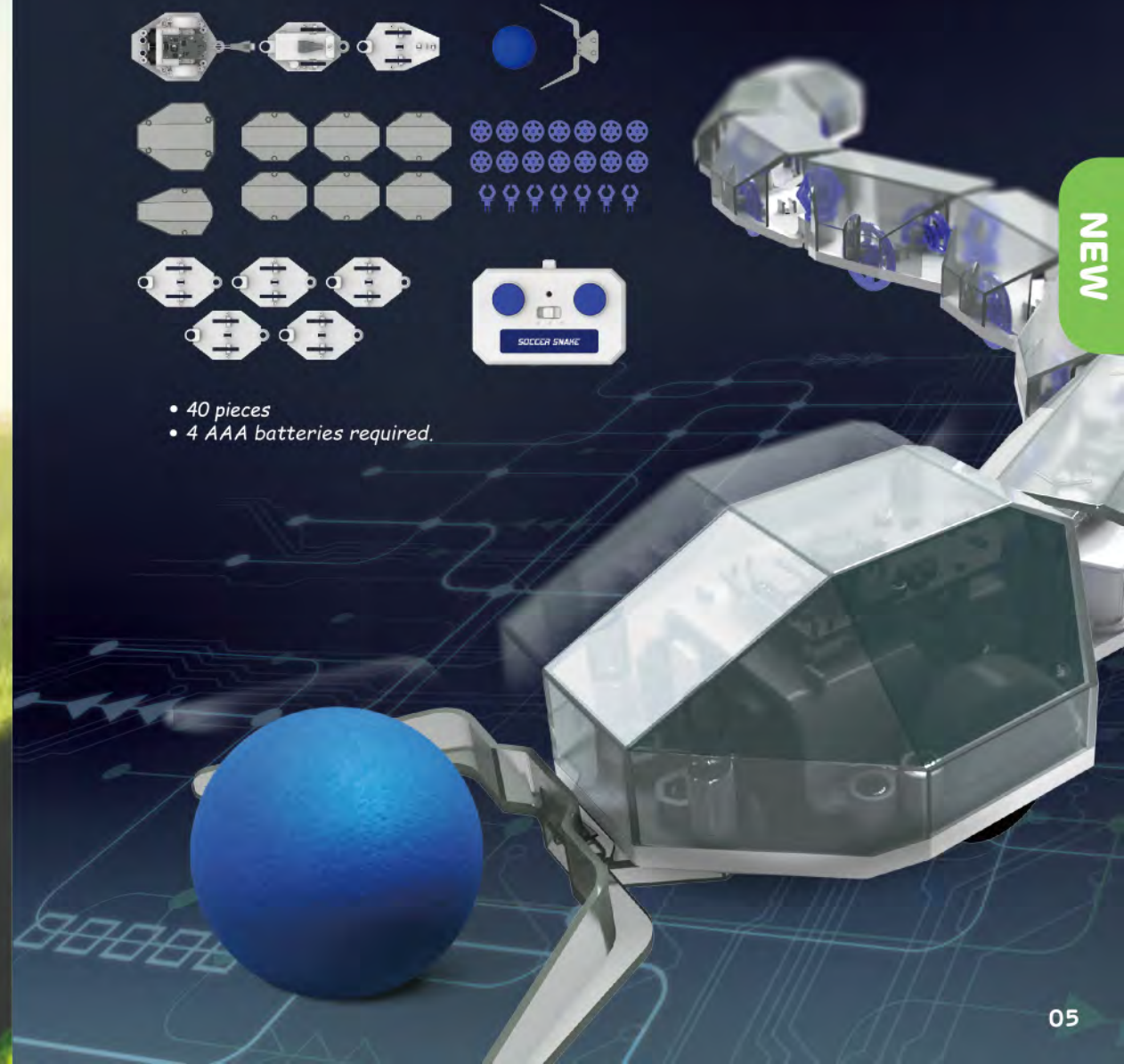

NEW



ages **8+** Item number **XP03801** Packing size **225X225X70mm**

TRIPLE POWER SPACE ROVER

Build your own space rover and learn about three different ways to generate energy when on the moon or another planet! Motorized rover is powered by three different energy sources: safe chemical battery, solar energy and battery power. Learn about real planetary rovers and how they work. Included Learning Booklet provides fun learning activities as well as instructions.



Chemical



Solar



Battery

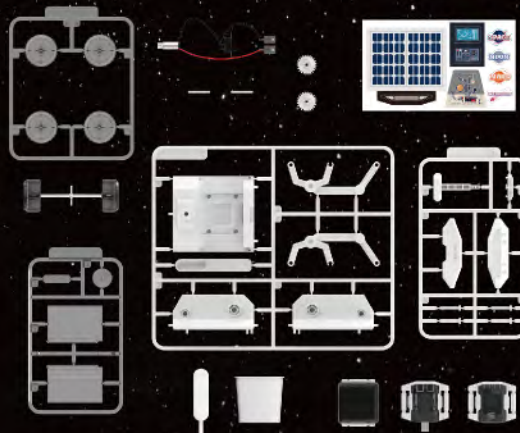

- 16 pieces
- 1 LR44/ AG13 button battery included.

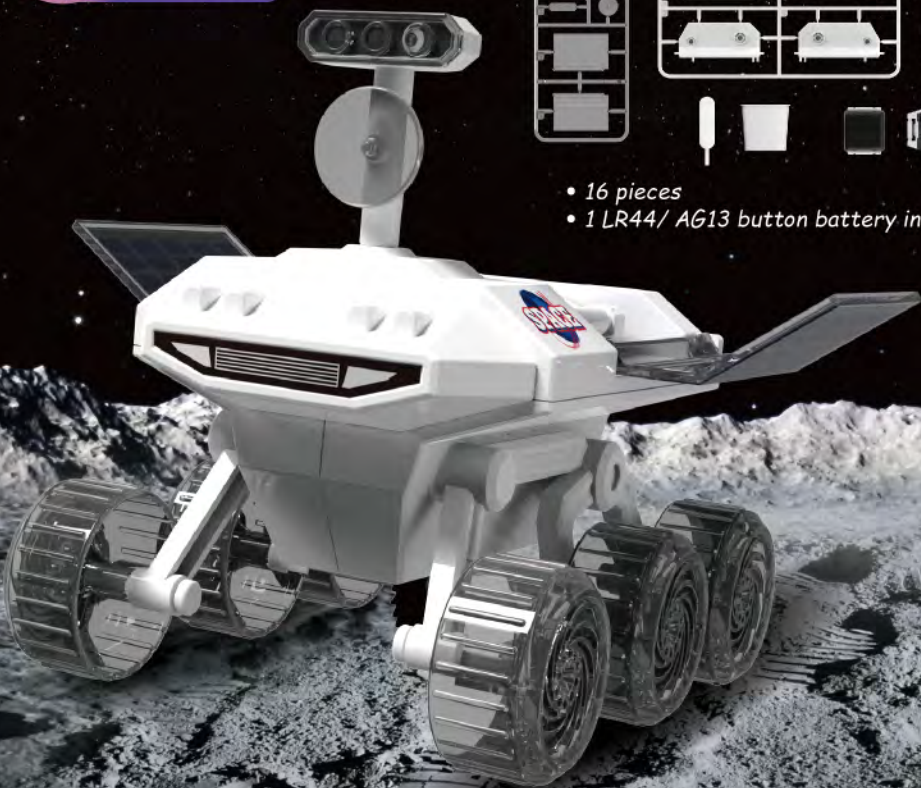

JET FIGHTER SCIENCE 2in1

Assemble two jet fighters and launch them by hand or slingshot! The airplanes are made from a special foam which is resistant to bending and breaking. The perfect treat for little aviators!

ages **6+** Item number **XP04401** Packing size **225X225X50mm**



F16&F18



• 12 pieces

NEW



ages **6+** Item number **XP04402** Packing size **225X225X50mm**



FALCON&HORNET



• 12 pieces



ages
6+

Item number
XP04601

Packing size
225X225X70mm

NEW

DUAL POWER SOLAR RACER

Assemble your own eco-friendly and fun DIY car that uses the power of both solar and battery technology. With its dual power design, you can play with it no matter the weather, and explore the science behind solar energy in a hands-on way.



- | | | | |
|---|---|---|---|
| 1 | 2 | 3 | 4 |
| 5 | 6 | 7 | 8 |

- 18 pieces
- 1 AA battery required



ages
6+

Item number
XP04501

Packing size
340x225x75mm

NEW

DUAL POWER SOLAR ROWBOAT

Experience the simplicity of traditional rowboat design combined with the innovation of modern solar power in this unique DIY boat. With classic oar-powered propulsion and solar energy capabilities, you can enjoy a fun and educational experience while learning about the mechanics and benefits of both technologies.

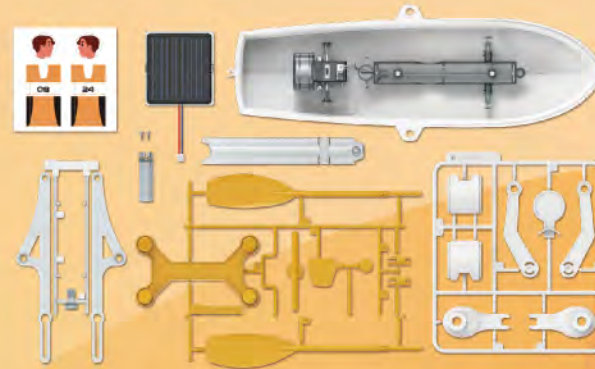

- 10 pieces
- 1 AA battery required

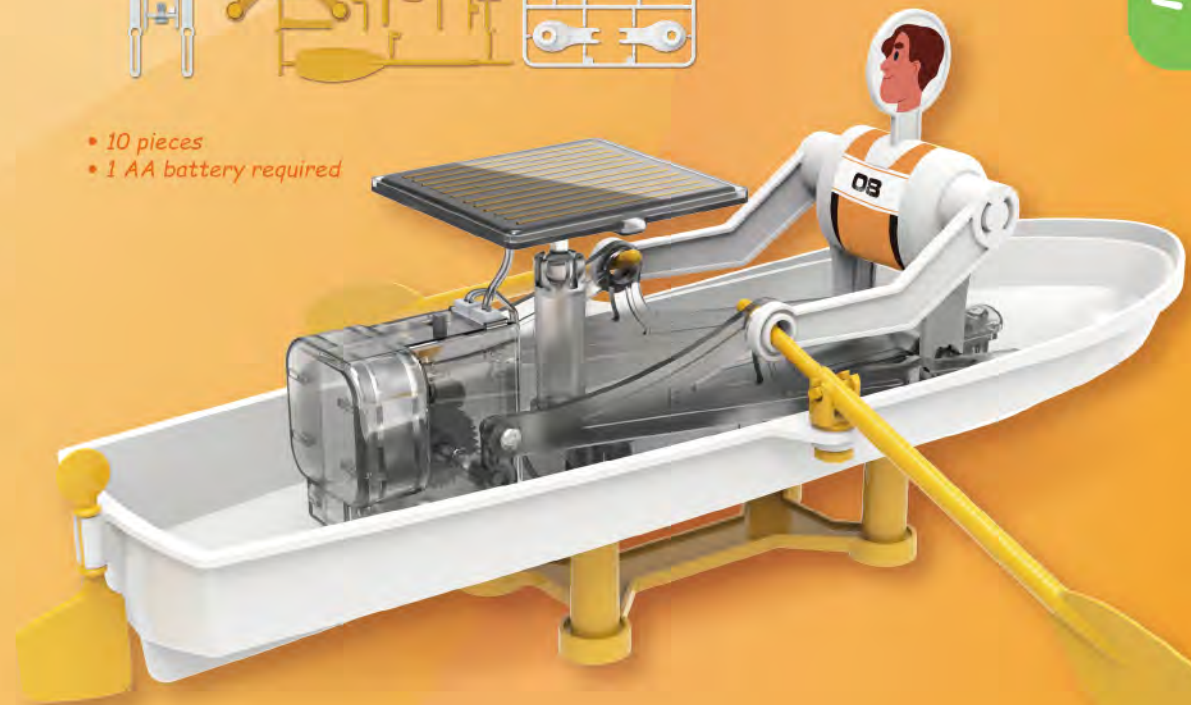

NEW

ages
6+

Item number
XP04701

Packing size
225X225X70mm

NEW

AIR BULLET CAR CHALLENGE

This is an exciting toy that includes two sets of bullet cars in red and blue. The cars are propelled by easy-to-use hand-smash air pumps that teach kids about air pressure while providing a thrilling experience. The set also comes with challenge games that offer fun and engaging play.

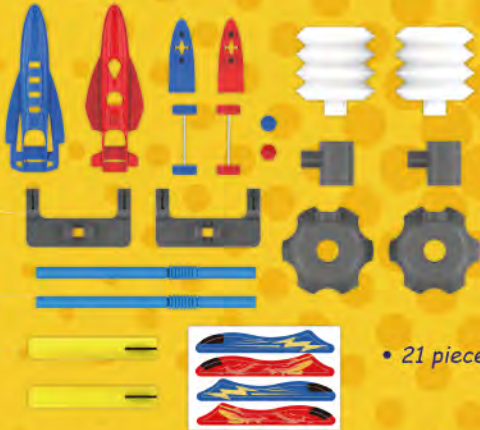

• 21 pieces



THE HOME SERIES

The HOME series is designed to do more than just bring parents and kids together for fun – it's also about learning and exploring the world around us. Each toy in this series is carefully crafted to encourage scientific inquiry and discovery, while still being accessible and enjoyable for all ages.



 **reddot award 2019**
winner

ages **8+** | Item number XP00301 | Packing size 225X225X70mm

WIND POWERED MOTOR GLIDER

The world's first wind-powered motor glider. Assemble your own Wind Turbine. Learn how to convert wind into electricity to light up an LED and power your Motor Glider!



THE SPACE WEATHER STATION

The All-in-One Weather learning kit, complete with Water Cycle Simulation. Great for decorating your home!

ages **8+** | Item number XP00101 | Packing size 225X225X70mm



PLANT MAZE BOTANY KIT SET

Be a little Botanist! Observe root and leaf growth. Learn about Geotropism and Phototropism.

ages **8+** | Item number XP00201 | Packing size 225X225X70mm



HOME

ages
8+

Item number
XP00401

Packing size
225X225X70mm

WATER POWERED ROCKET SCIENCE KIT SET

Includes everything you need to play and learn about the Water Rocket: a rocket, launch platform, a pump, and a detailed instruction booklet. The rocket can fly up to 30 meters high.



ages
8+

Item number
XP00801

Packing size
225X225X70mm

ATMOSPHERIC TURBO RACER

No battery required! Build your own air-powered racer. It's an All-in-One science learning kit about Atmospheric Pressure.



ages
6+

Item number
XP03601

Packing size
225X225X70mm

MY FIRST WATER ROCKET

Be a rocket scientist and launch your first water rocket. It's very easy to assemble as it does not require any tools or glue. Just pump it up and when the pressure is topped off, it launches. Learn about rocket thrust and experiment with different combinations of water and air to see how high it will fly!



ages
8+

Item number
XP00803

Packing size
225X225X70mm

ATMOSPHERIC INFERNO TURBO RACER

Join the race with the air powered Turbo Racer. Learn about pressure and engineering with this really fun science kit. Does not require battery, fully air pressure powered. Assemble, pump it up and let it GO!



ages **8+** | Item number XP03101A | Packing size 225X225X70mm

CLIMBING DINOS TRICERATOPS & T-REX

Build your Triceratops and watch him climb. The three-headed front wheels help it climb across almost any household obstacle. Change it to a T-Rex and watch it hop around the house.

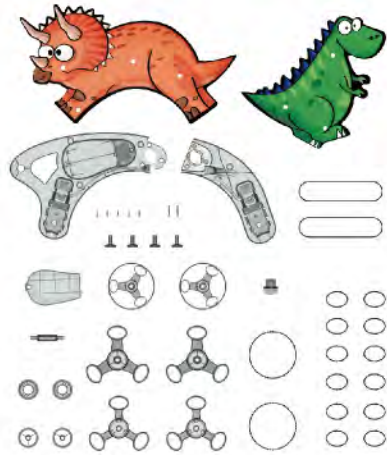

- 44 pieces
- 2 AA batteries required.

ages **8+** | Item number XP03101 | Packing size 225X225X70mm

CLIMBING CAT & HOPPING MOUSE

Build the most agile climbing cat. Its special three-headed wheels allow it to cross over any obstacle. Change it to a mouse and let it parade in the house.

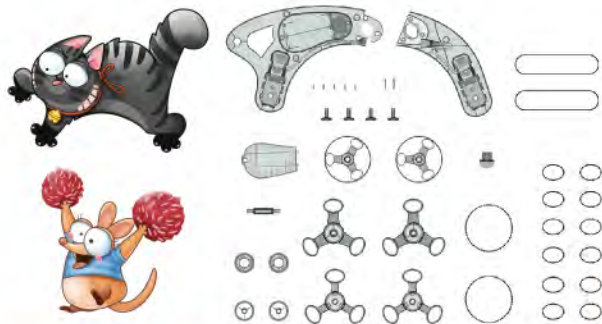

- 44 pieces
- 2 AA batteries required.

ages **8+** | Item number XP00501 | Packing size 225X225X70mm



ARTS ROBOT SPIRAL FACTORY

Build your own Arts Robot Factory. Recycle and hire a Tin Can to be your factory worker. Instruct it to create various spiral works of art for a museum. Comes with bundles of cards.



- 34 pieces
- 2 AA batteries required.

ages **8+** | Item number XP00603 | Packing size 225X225X70mm

BIONIC ROBOT SOCCER SNAKE

Assemble a wire-controlled robotic snake with two speeds. It is both fast and agile! Control your robotic snake and become the best soccer player of all! Goal!



- 40 pieces
- 4 AA batteries required.

ages **8+** | Item number XP01901 | Packing size 225X225X70mm

AERO SCIENCE COMBO SET

Includes five flying machine sets: Chemical Rocket, Egg Parachute, Green Flying Stick, Hula Loop Plane, Rubberband Helicopter.

Each flying machine set has specially designed instruction cards to encourage kids of all ages to let their imaginations fly far and high as they share in the joy of learning more about aeronautics.



• 76 pieces



ages **8+** | Item number XP01104 | Packing size 225X225X70mm

AIR ROCKET CHALLENGE

Load your rocket and challenge a set of targets from anywhere, compete with your best mate to see who the best sniper is. Learn about thrust and rocket trajectory. Time for target practice, THREE-TWO-ONE, FIRE!



• 43 pieces



ages **8+** | Item number XP00701 | Packing size 225X225X70mm

BIONIC ROBOT FROGZILLA

Build your own little green frog with specially designed blade shaped robotic legs. Try it on different terrains and it will hop and turnover. What a naughty green frog! Glug, Glug!



• 29 pieces
• 1 AA battery required.

ages **8+** | Item number XP01401 | Packing size 225X225X70mm



3D GALAXY PROJECTOR

PCT/CN2019/075169

Completely Glass Free! Project the Galaxy on the wall. Twist and rotate to observe the planets in 3D. Learn about the origin of the Solar System.



• 14 pieces
• 4 AAA batteries required.



HOME

ages **8+** | Item number XP02001 | Packing size 225X225X70mm

LINE TRACKING SIGHTSEEING BUS

Build your own city tour bus. Customize your sightseeing route. Learn about the world's most famous landmarks. Drive safe and the red bus goes around.



- 14 pieces
- 2 AA batteries required.

ages **8+** | Item number XP02102 | Packing size 225X225X70mm

TRIPLE SAFE CUBE

A secret magic box you will be the only one who knows how to open. With fake openings to confuse anyone who would dare to try and a ten digit combination lock, your secret is safely kept.



- 22 pieces

ages **3+** | Item number XP01803 | Packing size 225X225X70mm

KONG CALCULATOR

Learn mathematics while having fun with the Kong. Pick up question cards and count with bananas, then ask the Kong to check the answer. Ho-Ho the Kong is so smart!



- 12 pieces

ages **8+** | Item number XP02201 | Packing size 225X225X70mm



- 34 pieces

PATTERN SECRET LOCKER

An ultimate secret locker protected by sliding password. No battery required. Define your own password pattern and keep your secret safe. It can be any pattern you can think of.



Aeroplane

Science

The perfect line of toys for kids who are fascinated by the world of aviation. Our planes will help you explore the science of flight. Get ready to soar to new heights with PlaySTEM!

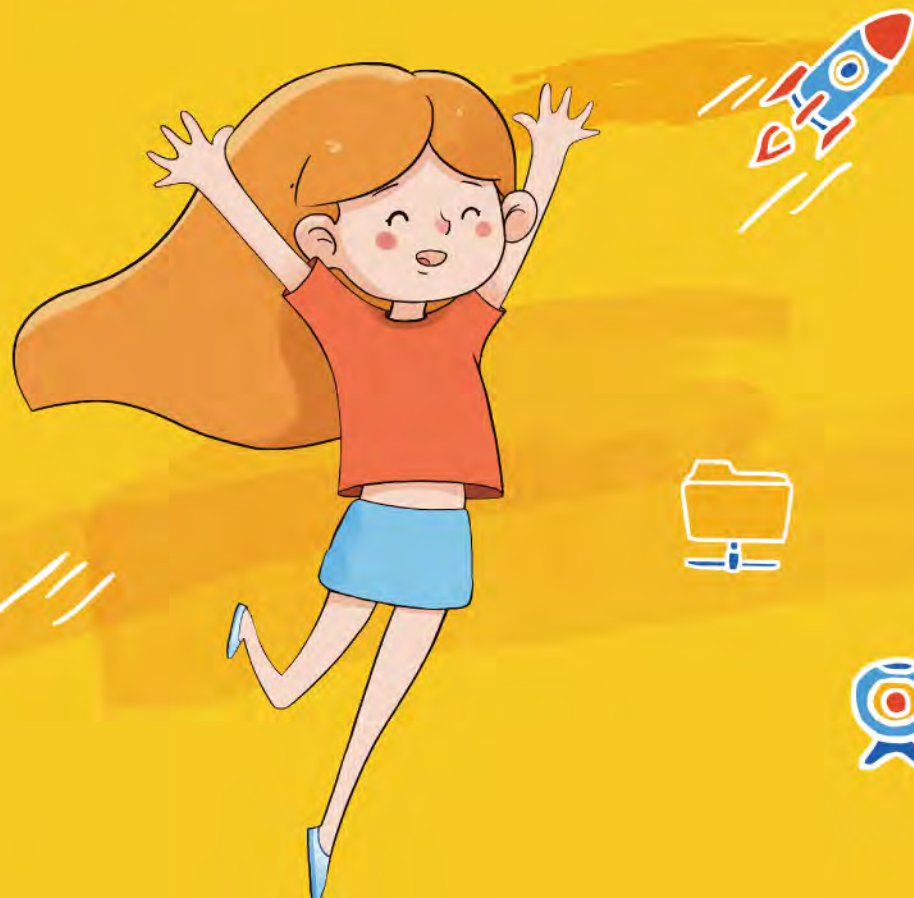

ages **14+** | Item number XP04203 | Packing size 340x225x75mm

RUBBER BAND AEROPLANE SCIENCE 3 IN 1

Vintage rubber band aeroplane models with modern graffiti design. The set includes a seaplane, a low-wing plane and an electric rubber band winder. Easy snap assembly, wind and take off! Learn about aerodynamics.

*The rubber band winder is also a standalone product.

ages **8+** | Item number XP04301 | Packing size 130x40x(190+25)mm



AEROPLANE



- 40 pieces
- 2 AA batteries required.

MODERN SERIES

**RUBBER BAND
AEROPLANE
SCIENCE**

Assemble and fly your own airplane model and learn about aeronautics. Select from four distinct aircraft designs, each featuring bold graffiti graphics.

Name	Item number	Packing size	Age
Biplane	XP04201A	225X225X50mm	14+
Seaplane	XP04201B		
High Wing	XP04201C		
Low Wing	XP04201D		



Biplane



Low Wing

High Wing

Seaplane

CLASSIC SERIES

**RUBBER BAND
AEROPLANE
SCIENCE**

Classic Series offers 4 different vintage aircraft models in 4 distinct categories: high wing, low wing, seaplane, and bi-plane. You'll want to build them all because they all fly great!

Name	Item number	Packing size	Age
Sopwith Camel	XP04202A	225X225X50mm	14+
DHC-2 Beaver Seaplane	XP04202B		
J-3 Cub	XP04202C		
P-40 Warhawk	XP04202D		



J-3 Cub



P-40 Warhawk

Sopwith Camel

DHC-2 Beaver Seaplane

AEROPLANE

Love the Ocean

Recycle and Make × *be the blue advocate*

"Love the Ocean" series products present a new concept of engaging science toys dealing with one of the most important challenges of this century. Turning the ocean pollution concern into an interesting topic, it gives children the keys to explore possibilities of recycling while having fun.



ROBOTIC FISH

Learn about fish swimming mechanism and BIONICS with the Robotic Fish. Assemble it, turn it "ON" and watch it swim like a real fish. Make and swim.

age
6+

Item number
XP02901

Package size
225X225X70mm



- 29 pieces
- 1 AA battery required.

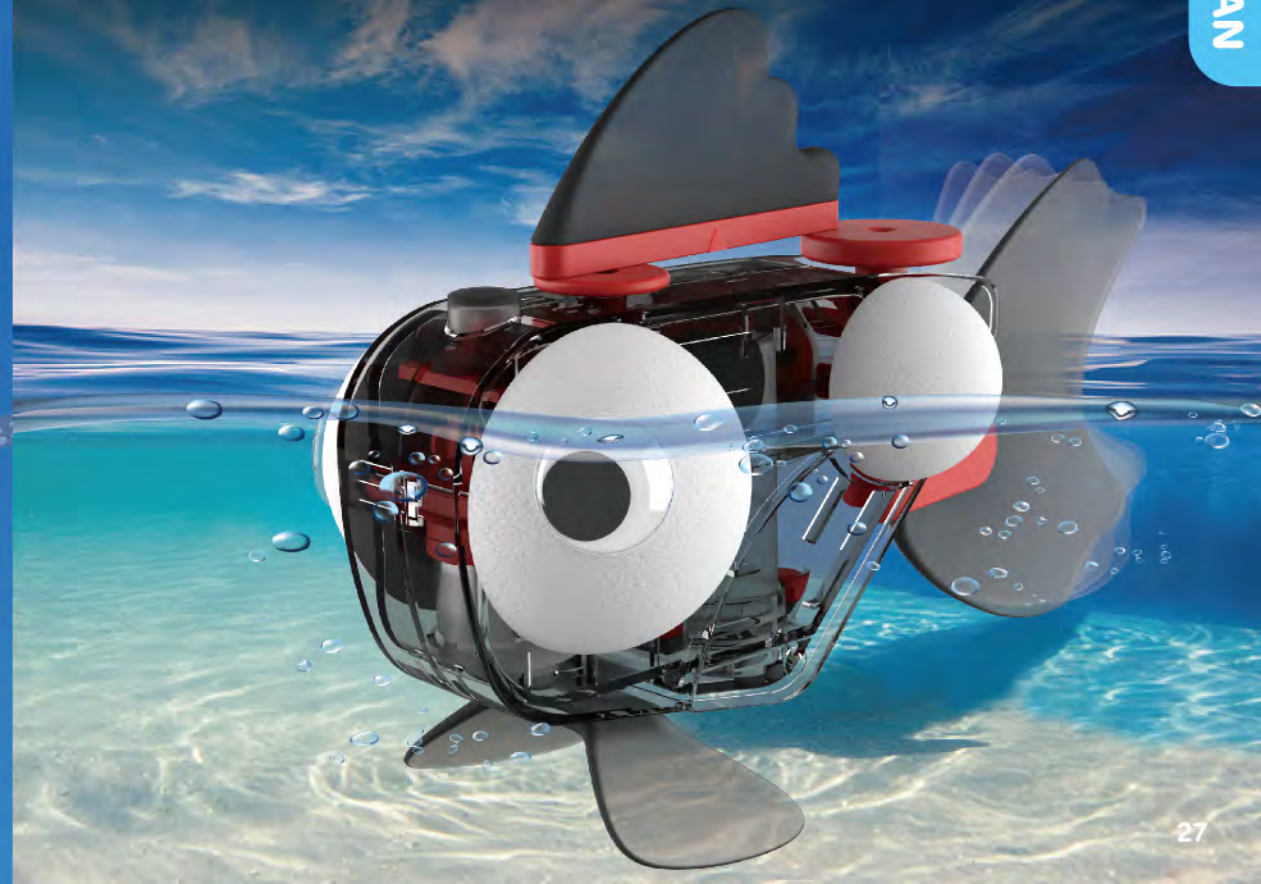

OCEAN FRIENDS HAMMERHEAD SHARK & MANTA RAY

Recycle empty plastic bottles to make swimming ocean creatures and then learn about them. Attach your creature's body to the underwater motor unit to bring it to life. Make them all!

age **6+** | Item number XP02801A | Package size 225X225X70mm



- 24 pieces
- 1 AA battery required.

OCEAN FRIENDS WHITE SHARK & SQUID

Recycle empty plastic bottles to make swimming ocean creatures and then learn about them. Attach your creature's body to the propelling system to bring it to life. Make them all!

age **6+** | Item number XP02801B | Package size 225X225X70mm



- 23 pieces
- 1 AA battery required.

OCEAN FRIENDS SEA TURTLE & CRAB

Assemble recycled bottle caps with the Recyclips™ to make various marine animals and then learn about them. Bring them to life with their vibrating body. Make them all!

age **6+** | Item number XP02701B | Package size 225X225X70mm



- 61 pieces
- 1 AAA battery required.

OCEAN FRIENDS LOBSTER & OCTOPUS

Assemble recycled bottle caps with the Recyclips™ to make various marine animals and then learn about them. Bring them to life with their vibrating body. Make them all!

age **6+** | Item number XP02701A | Package size 225X225X70mm



- 63 pieces
- 1 AAA battery required.

GREEN SEACOAST ARCHITECT

Use paper straws to build a green and eco-friendly seacoast with a lighthouse and offshore windmills. Understand the importance of plastic straw recycling and learn about seacoast infrastructures. Build them all!

age **6+** | Item number XP01601A | Package size 225X225X70mm

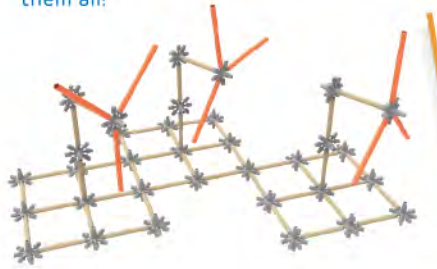

  • 220 pieces

OCEAN CLEANING SEAHORSE

It's the best science toy to learn about buoyancy. Play an interactive game to clean the Ocean. Comes with 10 beautiful postcards explaining Ocean conservation knowledge.

age **3+** | Item number XP01701A | Package size 150X210X70mm



• 8 pieces



ToGo
Fun on the road

SCIENCE

Science to go series is a set of fun, meaningful and budget-friendly science toys.

Carefully designed with safety as a first concern, Science to go toys are aimed to spark children's interest in science.

Grab-and-Play to get inspired in a maximum of fun. Grab them All!



ages **3+** Packing size 110X200mm



Deep Diving Seahorse

Item number: XP01703

Learn about buoyancy with the diving sea horse. Squeeze the bottle to increase the pressure in it and make your seahorse dive to pick up seashells and sea-stars. How many of them can you pick up at once?

• 8 pieces

ages **8+** Packing size 110X200mm



Dancing Illusion

Item number: XP03401

Pick a pattern, attach it to the top, spin it and see what happens to the pattern, learn about physics and momentum, amazing!

• 8 pieces



Arrow Copter

Item number: XP03201

Fire your Arrow Copter high in the sky, it will fall back spinning like a Helicopter. Watch the Copter spin and learn basic aerodynamics.

• 6 pieces

ages **8+** Packing size 135X190X20mm



Bridge Architect

Item number: XP03301

Build the bridge step by step as a real architect. You have probably noticed that most bridges, including yours, have slanted beams in the middle of the structure.

• 123 pieces

ages **5+** Packing size 135X190X20mm



Band Powered Copter - Dinos

Item number: XP01203C

Wound your Copter up to store energy in the rubber band. Release it, the energy will transfer to the propeller to make it soar into the sky. Which of your little animal buddies will fly the highest?



• 20 pieces



Band Powered Copter - Dreams

Item number: XP01203B

Wound your Copter up to store energy in the rubber band. Release it, the energy will transfer to the propeller to make it soar into the sky. Which of your little animal buddies will fly the highest?



• 20 pieces



Band Powered Copter - Tales

Item number: XP01203A

Wound your Copter up to store energy in the rubber band. Release it, the energy will transfer to the propeller to make it soar into the sky. Which of your little animal buddies will fly the highest?



• 20 pieces

Togo

ages
8+ Packing size
135X190X20mm



Hula Loop Plane

Item number: XP01003

The Hula Loop Plane is designed to fly back to you in a perfect loop. Throw it gently, it will gently loop back. Throw it faster, it will quickly loop back in a smaller loop.



ages
5+ Packing size
150X210X55mm



Table Top Air Rocket

Item number: XP01103

Launch your rocket from anywhere even from Mars by turning the box into a Mars landscaped stage. Learn about rocket thrust and pressure, THREE-TWO-ONE- FIRE



ages
8+ Packing size
135X190X40mm



Reaction Rocket

Item number: XP02501

Fill the rocket with baking soda and the launcher with vinegar. Position your rocket on the launcher, the chemical reaction between the soda and the vinegar will propel your rocket.



Green Powered Grand Prix

Item number: XP01503

Take part in the Grand Prix with your rubber band-powered car and find out the relation between potential and kinetic energy. Buckle your seat belt VROOM!



ages
8+ Packing size
150X210X55mm



Magic Vision

Item number: XP03501

Pull the rope and let it go, the pictures will rotate and appear to blend into one. Learn about persistence of vision.



Green Straw Architect

Item number: XP01603

Green straw architects teaches geometry through model building, allowing anyone to create structures using green paper straws and connecting joints. Awaken the architect within you!



ACTIVE SERIES

Head outdoors to have fun with PlaySTEM Active Series science toys. Learn about alternative power when you play with our sailboats and solar boat or imitate the flight of birds with PlaySTEM ornithopters. Having fun while learning is the cornerstone of PlaySTEM design and culture.



ages
14+

Item number
XA01008

Package:
3.5" x 11" x 0.5"
90 x 280 x 13mm

IRON BIRD RUBBER BAND POWERED ORNITHOPTER

- Rubber band power & bamboo structure
- Listen and watch the wings flap
- Adjust the flying trajectory
- Perfect activity for indoors and outdoors



• 14 pieces



ages
14+

Item number
XA08301

Package:
4.5" x 9.5" x 1"
110 x 240 x 25mm

DARK WINGS RUBBER BAND POWERED ORNITHOPTER

- Cool scheme
- Improved carbon fiber structure
- Box package



• 15 pieces



SKY CUB

2.4GHz RC Plane

- Wingspan 21 inches
- Flight Battery 3.7V 1S 150mAh LiPo Battery (included)
- Magnetic adaptive wing
- Light weight foam construction
- Easy to fly for beginners
- 99% completed, charge and fly
- Controller with battery charging port



DURABLE

The wing automatically detaches in crash

- 4 AA batteries required for the transmitter.

ages **14+** Package: 28.3" x 12.2" x 6.2" 610 x 265 x 130mm

Item number: XA04701A



FALCON 900

ages **14+**

Package: 28.3" x 12.2" x 6.2" 720 x 310 x 160mm

Item number: XA02601

2.4GHz RC RTF Motor Glider

- Wingspan 35 inches
- Flight Battery 7.4V 2S 420mAh, 20C LiPo Battery (included)
- Durable foam construction
- Easy to fly for beginners
- Quick and easy assembly
- USB Battery Charger included
- Reliable 2.4GHz control system



- 4 AA batteries required for the transmitter.

Global Hawk

ages **14+**

Package: 32.8" x 14.5" x 9.6" 835 x 370 x 245mm

2.4GHz RC RTF Trainer with optional floats

Item number: XA08802A (Red) XA08802B (Blue)

- Wingspan 48 inches
- Flight Battery 11.1V 3S 1800mAh, 25C LiPo Battery (included)
- 3 operational modes for Beginner, Advanced and Professional lets you fly to your capabilities
- 6-axis gyro system provides self-correcting performance for stable flight in Beginner mode
- Includes One Button Rescue, Throttle Lock and Low Voltage Protection
- Durable EPP foam construction
- Easy to assemble with pre-installed servos and linkages



- 4 AA batteries required for the transmitter.

ACTIVE

280 VOYAGER

2.4GHz RC Sailboat

- Length 280mm (11 in), Width 85mm (3.3 in), Height 445mm (17.5 in), Scale: 1/43.
- 2-channel control. Transmitter controls the sail angle and the water rudder.
- Equipped with 2 9-gram servos, 3.7V 150mAh Li-Po battery. Li-Po battery charger is built into the transmitter.
- No assembly required
- Includes display stand
- Requires AA batteries (x4)

ages **14+** Package: 12.5" x 19" x 4.25" 313 x 483 x 110mm

Item number: **XB03401A (red)**
XB03401B (blue)
XB03401C (green)



400 VOYAGER

2.4GHz RC Sailboat

- Length 400mm (15.75 in), Width 100mm (4 in), Height 672mm (26.5 in), Scale: 1/30.
- 2-channel control. Transmitter controls the sail angle and the water rudder.
- Equipped with 2 9-gram servos, 3.7V 150mAh Li-Po battery. Li-Po battery charger is built into the transmitter.
- No assembly required
- Includes display stand
- Requires AA batteries (x4)

ages **14+** Package: 16.75" x 27.5" x 5" 428 x 700 x 120mm

Item number: **XB03402A (red)**
XB03402B (blue)



VOYAGER

2.4G RC Motor Powered Sailboat

- Includes detachable electric motor for fun sailing indoors or when there is no wind.
- 3 channel control. Transmitter controls the sail angle, the water rudder and the motor.
- Equipped with 2 9-gram servos, 3.7V 150mAh Li-Po battery. Li-Po battery charger is built into the transmitter.



Attachable Electric Motor

ages **14+**

• 4 AA batteries required for the transmitter.

Item number	Name	Scale	Product Size	Packing size
XB05001A (red)	VOYAGER 280	1/43	280*85*445mm	313*110*483mm
XB05001B (blue)	Motor Powered		11*3.3*17.5 in	12.3*4.3*19in
XB05002A (red)	VOYAGER 400	1/30	400*100*672mm	428*120*700mm
XB05002B (blue)	Motor Powered		15.8*4*26.5 in	16.9*4.9*27.6 in

* See pages 40 for non-motorized VOYAGER 280 and 400



ACTIVE

PLAYSTEM ZTF 1/22 SERIES

2.4GHz RTR 4WD RC Car

A lineup of three high-performance cars for ultimate versatility. Each vehicle in the series boasts a unique body style and driving experience. They are evolved from the same durable and flexible platform ZTF. The smooth control makes the series an excellent choice for both beginning and experienced RC enthusiasts.

Quick features

- Tough, pre-painted body with decals
- ZT MODEL Flat chassis platform
- Four-wheel drive for superior traction and acceleration
- Powerful motor for exciting speed
- Ready-To-Run with included 7.4V Li-Po battery and USB smart charger
- Soft-compound tires
- Fully independent suspension for exceptional road handling and control
- Durable construction that's built to last

Key specs

	Rally	Touring Car	Pickup Truck
Size	200 * 105 * 75 mm 7.8" * 4.1" * 3"	215 * 105 * 69 mm 8.5" * 4.1" * 2.7"	215 * 105 * 96 mm 8.5" * 4.1" * 3.8"
Wheelbase	120 mm / 4.7"		
Motor	130 Brushed		
Speed	30 km/h / 18.6 mph		20 km/h / 12.4 mph
Drive system	Shaft-driven 4WD		
Radio system	2.4GHz Radio		
Included Batteries	3.7V 380mAh Li-Po Battery		

- 4 AA batteries required for the transmitter.

RALLY

ages
14+

Item number
XC01201

Packing size
9.7" * 7.2" * 8.2"
246 x 183 x 208mm



TOURING CAR

ages
14+

Item number
XC01501

Packing size
9.7" * 7.2" * 8.2"
246 x 183 x 208mm



PICKUP TRUCK

ages
14+

Item number
XC01601

Packing size
9.7" * 7.2" * 8.2"
246 x 183 x 208mm



ACTIVE

GT3 ROAD RACER

PLAYSTEM ZTF 1/18 GT Car



ages	Item number	Packing size
14+	XC01801	11.8" * 7.2" * 8.2" 300 x 183 x 208mm

Built with precision and attention to detail, this car is designed to provide a realistic driving experience. With its high-performance motor and responsive handling, you'll be able to hit top speeds and navigate sharp turns with ease. Whether a pro or a newcomer, the GT3 Road Racer is sure to impress!

Quick features

- 1/18 tough, pre-painted body
- Four-wheel drive for superior traction and acceleration
- Powerful 370 motor
- Ready-To-Run with included 7.4V Li-Po battery and USB smart charger
- Fully independent suspension for extraordinary on-road handling
- Front and rear gear differentials
- Soft-compound tires
- CNC-machined transmission parts
- Durable construction that's built to last

Key specs

Size	10.2" * 4.8" * 3" 260 * 123 * 75mm
Wheelbase	160mm / 6.3"
Motor	370 Brushed
Speed	40km/h / 24.9 mph
Drive system	Shaft-driven 4WD
Radio system	2.4GHz Radio
Included Batteries	7.4V 2S 900mAh Li-Po Battery

- 4 AA batteries required for the transmitter.



Play, read, and inspire are at the heart of PlaySTEM's approach to learning. By providing children with hands-on experiences and exposure to new ideas, we can spark their curiosity and inspire them to explore further.

WWW.PLAYSTEM.COM

SALES@PLAYSTEM.COM